

JVC®

The Perfect Experience / —
/

HD/SD Memory Card Camcorder

GY-HM790E

ProHD



CLASS E
CLASS E

Unsurpassed Versatility

The above picture shows the GY-HM790E with the optional battery.

JVC Introduces a Camcorder with Best-in-Class Performance for All Professionals

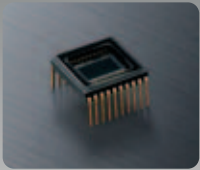

Designed to Achieve Higher HD Picture Quality with JVC's Advanced Technologies

The three 1/3-inch progressive CCD design works in conjunction with JVC's original Triplex Offset technology to dramatically increase horizontal, vertical and diagonal resolution. The high-performance DDSP (Dynamic Digital Signal Processor) allows you to achieve pictures of stunning definition up to full progressive 1920 x 1080. These technologies are complemented by the true HD 14x zoom lens from Canon, offering less chromatic aberration and higher resolution throughout the zoom range.



35
Mbps

Cover All Major Signal Formats from SD to HD

JVC not only implemented a ubiquitous MPEG2 codec capable of providing highly efficient compression of full HD 1920 x 1080 up to 35 Mbps, but also addressed a range of industry needs with SD recording, covering all the major signal formats.

Building upon a wealth of innovative technologies, JVC introduces a best-in-class professional camcorder. The GY-HM790E packs uncompromising quality and functionality, meeting the wide ranging demands of industry professionals, all in a compact, ergonomic body.

QuickTime MOV / XDCAM EX™ / AVI File Format Recording

With full recording compatibility with the following formats, you can take advantage of accelerated workflow enabled through Native File Recording capability.

- QuickTime™ MOV, native file format recording (HD/SD) for direct file access to Apple FCP™
- XDCAM EX™ MP4 (HD), Seamless integration into XDCAM EX™ HD workflow
- AVI (SD), DV codec AVI file support for existing SD workflow

Note: MP4 is the compliant file format used on the XDCAM EX™. Recording file format onto SxS card is MP4 (HD) only.

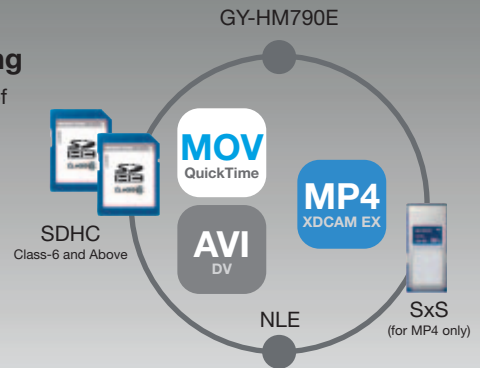

Dual Media Hybrid Recording to SDHC and SxS (optional)

In addition to the on-board twin SDHC card slots, the optional KA-MR100G allows for a range of hybrid recording possibilities, such as simultaneous recording to high-speed SxS media.



One Powerful Camcorder that Addresses the Needs of the Most Demanding Applications, from Studio to ENG and EFP

KA-MR100G
SxS Memory Card Recorder

Native File Recording for Direct NLE

KA-M790G
Multicore Studio Interface Unit

- Intercom, call, camera control, video/genlock, tally and other signals interface via 68-pin multi-connector
- 26-pin RM connector on back



Compact Shoulder Camcorder



Genlock In
TC In/Out

ENG

HD/SD ENG System



Photo courtesy of Newport Television

Performance and Maneuverability in a Standalone Camcorder

Featuring dual media hybrid recording, the GY-HM790E covers everything from Full HD to industry-standard SD recording, supporting a range of formats natively including MOV, MP4 and AVI, for broadcast quality performance in any news-gathering situation.

EFP

HD/SD EFP System



Photo courtesy of Miami Dolphins

Expansion Capability for Multi-camera Recording

The capability of image capture using multi-camera operations is made possible. In addition, with the Telecast Copper Head, it's possible to expand your production over an even greater distance.



**KA-M790G
Multicore Studio Interface Unit**

- Intercom, call, camera control, video/genlock, tally and other signals interface via 68-pin multi-connector
- 26-pin RM connector on back

- Long-Distance Fibre Configuration is possible by using the optional ProHD Fibre System

- VF-HP790G
8.4" LCD Studio Viewfinder**
- XGA (1024 x 768 pixels) LCD studio viewfinder
 - External SDI input

- KA-790G
Studio Sled Support**
- To accommodate studio viewfinder, teleprompter and pedestal

STUDIO

HD/SD Studio System



Photo courtesy of Waterman Broadcasting Corp.

**Flexible Configuration
for Studio-based Program Production**

Create a highly robust studio camera setup by attaching the dedicated sled to your studio pedestal, complemented by JVC's high-resolution VF-HP790G HD Viewfinder and teleprompter. To lower integration costs, existing 26-pin control cables can be used to connect studio essentials, such as remote control units.

Uncompromising Features Cover

HD/SD ENG System

Photo courtesy of Newport Television

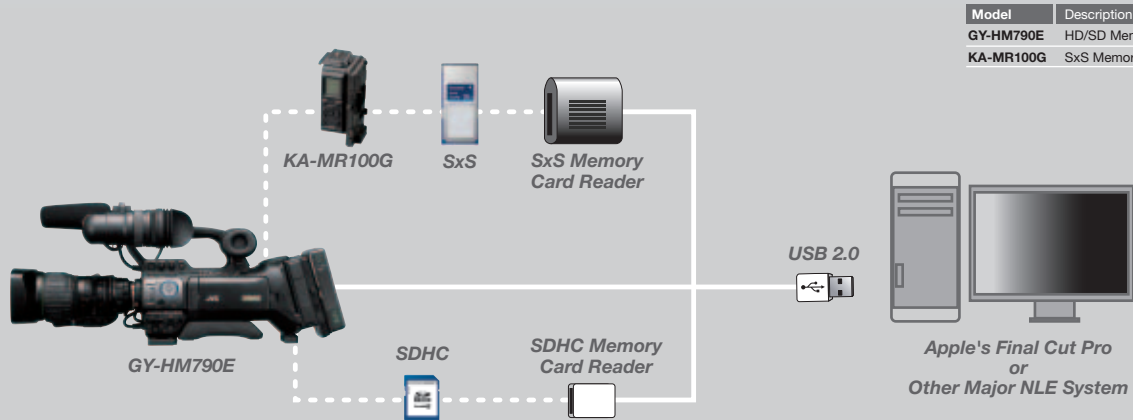

Model	Description
GY-HM790E	HD/SD Memory Card Camcorder
KA-MR100G	SxS Memory Card Recorder

- The GY-HM790E is an ergonomic shoulder-mount camcorder ideal for ENG applications.
- Both HD or SD recording is possible. MOV file format for Apple Final Cut Pro™ in both HD and SD modes. XDCAM EX™-compatible MP4 file for HD and DV-based AVI format for SD in Windows NLE systems.
- Mounted with the optional KA-MR100G SxS recorder, simultaneous file recording to SDHC and SxS media is possible. KA-MR100G-recorded file is XDCAM EX™ compatible MP4 file only (HD).

- Optional ASI output adapter for field microwave transmission.
- Genlock input and time code input/output available for multi-camera operation.

Note: The optional ASI adapter cannot be used with KA-MR100G simultaneously.

HD/SD EFP System

Photo courtesy of Miami Dolphins

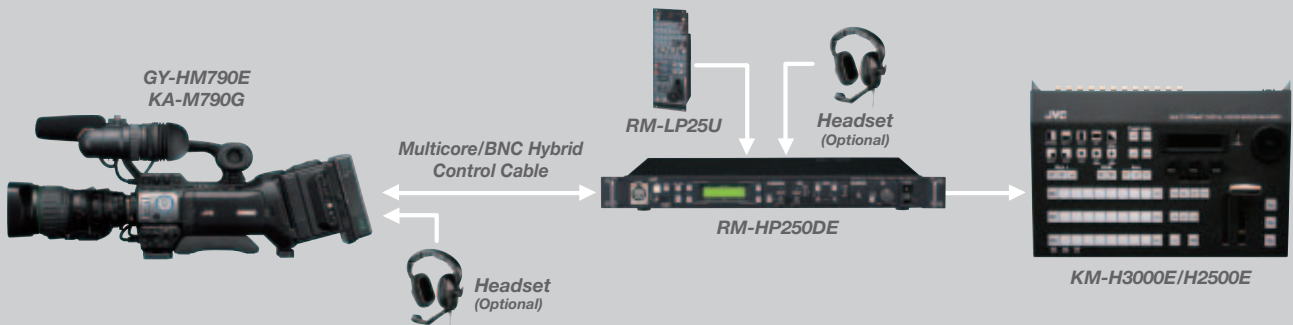

Model	Description	Model	Description
GY-HM790E	HD/SD Memory Card Camcorder	RM-HP250DE	Camera Remote Control Unit
KA-M790G	Multicore Studio Interface Unit	RM-LP25U	Remote Control Unit
Camera Cable	Multicore/BNC Hybrid Camera Cable	KM-H3000E/H2500E	Multi-format Digital Switcher

- Fitted with the KA-M790G, the GY-HM790E can be used to construct an economical HD or SD EFP system for stunning images.
- Both HD or SD component and SDI video are supported, giving user flexibility to use a component switcher or an SDI switcher.
- Lossless SDI output from GY-HM790E can be delivered to RM-HP250DE via multicore/BNC hybrid cable
- Flexible shoulder-mounted EFP operation with return video in the provided viewfinder.

- When connecting KA-M790G to an RM-P210E unit, users' existing 26-pin JVC or Sony multicore cable can be used.
- Excessive external cabling eliminated with internal multi-connector interface between camera and multicore, fibre and ASI adapters.
- Long distance operation also possible using ProHD Fibre Optical system by Telecast Copper Head 3000J system.

All of Your Workflow Possibilities

HD/SD Multicore Studio System

Photo courtesy of Waterman Broadcasting Corp.

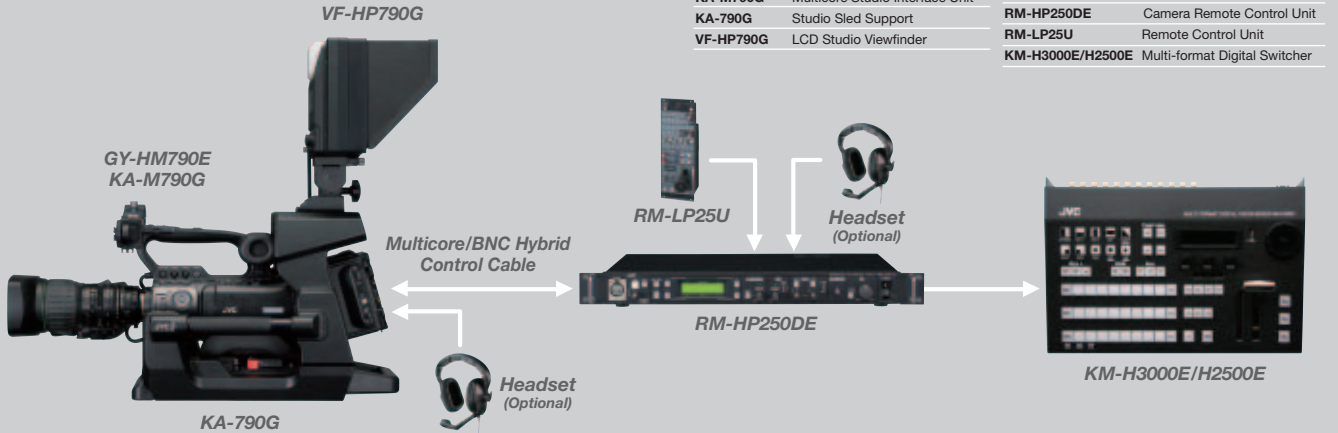

Model	Description	Model	Description
GY-HM790E	HD/SD Memory Card Camcorder	Camera Cable	Multicore/BNC Hybrid Camera Cable
KA-M790G	Multicore Studio Interface Unit	RM-HP250DE	Camera Remote Control Unit
KA-790G	Studio Sled Support	RM-LP25U	Remote Control Unit
VF-HP790G	LCD Studio Viewfinder	KM-H3000E/H2500E	Multi-format Digital Switcher

- Fitted with the KA-M790G and the KA-790G, the GY-HM790E can be used to construct an economical HD or SD studio system for stunning images.
- Both HD or SD component and SDI video are supported, giving user flexibility to use a component switcher or SDI switcher.
- Lossless SDI output from GY-HM790E can be delivered to RM-HP250DE via multicore/BNC hybrid cable

- When connecting KA-M790G to an RM-P210E unit, users' existing 26-pin JVC or Sony multicore cable can be used.
- Reliable tripod-mounted studio operation with pedestal and teleprompter.
- When needed, the GY-HM790E can be used as an ENG camera by releasing the camera from KA-790G.

HD/SD Fibre Studio System

Photo courtesy of Ole Miss Athletics & Media Support Group

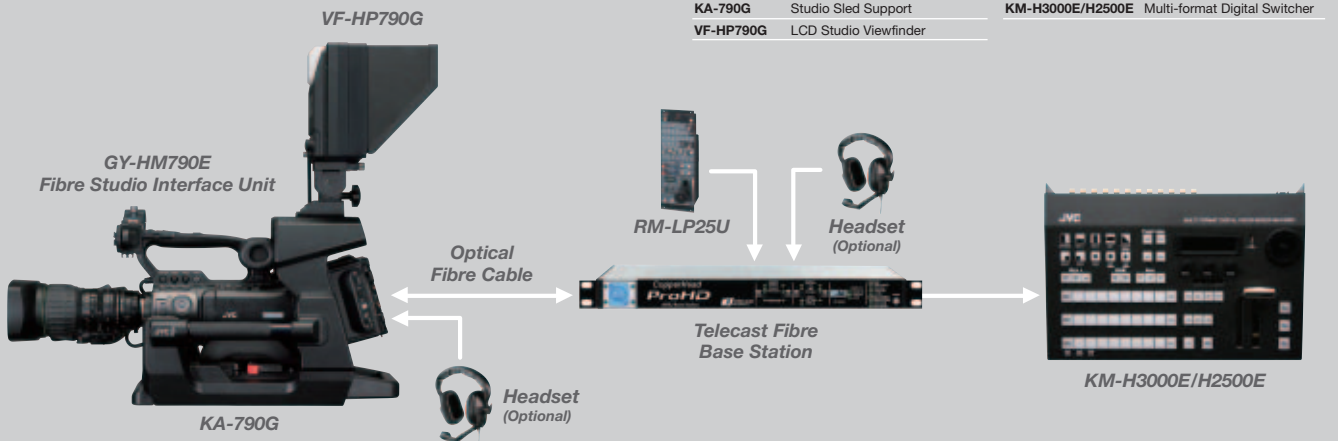

Model	Description	Model	Description
GY-HM790E	HD/SD Memory Card Camcorder		Telecast Fibre Base Station
	Fibre Studio Interface Unit	RM-LP25U	Remote Control Unit
KA-790G	Studio Sled Support	KM-H3000E/H2500E	Multi-format Digital Switcher
VF-HP790G	LCD Studio Viewfinder		

- Fitted with the ProHD fibre studio interface unit and the KA-790G, the GY-HM790E can be converted into an economical HD or SD studio system.
- Both HD or SD component and SDI video are supported, providing flexibility to use a component switcher or SDI switcher.

- Optical fibre system allows longer cable distance operation with optional Power Wafer.
- When needed, the GY-HM790E can be used for ENG by releasing the camera from the KA-790G studio sled support.

Innovation that Meets the Demands of Professionals — High-Resolution Image Quality

Best-in-Class High Resolution HD Rec



Three 1/3-inch Progressive CCD Design with Triplex Offset

The three progressive CCD design provides rich, accurate colours, while JVC original Triplex Offset technology, in conjunction with pixel correlation, adaptively increases the effective resolution both horizontally and vertically by shifting the red and blue pixels independently relative to the green, for a sharper picture without any corresponding loss in sensitivity. As a result, horizontal, vertical and diagonal resolutions are dramatically increased. Furthermore, using a global shutter, the design minimizes wobbling during quick pans and fixed pattern noise in low light conditions, contributing to a more stable image.

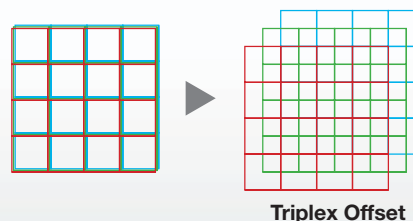
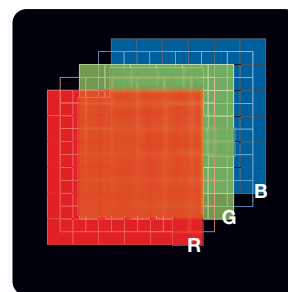
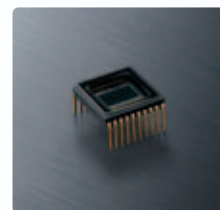
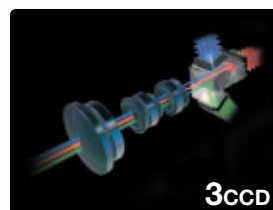

ording

Canon 14x HD Lens

The JVC GY-HM790E comes equipped with a 14x interchangeable HD lens from Canon. With a focal length down to 4.4 mm (equivalent to 31.7 mm on a 35 mm camera), the new lens is 20% wider than previous models, and at the telephoto end (up to 447 mm at 35 mm equivalent) it is less susceptible to colour flaring. Focus accuracy is maintained throughout the zoom range, and the same image brightness is sustained without reducing the F-stop.



Advanced MPEG2 High Bit Rate Encoding

1080p Dynamic Digital Signal Processor (DDSP)

At the heart of the GY-HM790E is the new Dynamic Digital Signal Processor. Processing is performed on the full progressive 1920 x 1080 signal, regardless of the camcorder's settings, ensuring the highest picture quality in any shooting mode. All major HD resolutions are supported, including 1920 x 1080, 1440 x 1080 and 1280 x 720.



JVC Proprietary 35Mbps MPEG2 Encoder (HD)

Drawing from its experience in developing transmission signal encoders used by major television stations, JVC developed a proprietary codec capable of providing highly efficient compression up to 35 Mbps — high enough to support full 1920 x 1080 encoding — capable of creating high resolution images with minimal artifacting. The XDCAM EX™ MPEG2 long GOP (Group of Pictures) codec is a widely used, broadcast-standard compression system and is supported by all popular editing systems and broadcast servers. The GY-HM790E supports all major HD signal formats including 1920 x 1080, 1440 x 1080 and 1280 x 720.



Standard Definition Recording Capability

Responding to the needs of the industry, the GY-HM790E, in addition to its capability as an HD recorder, offers Standard Definition recording for maximum flexibility. Recording in SD provides a time-saving alternative to down-conversion of HD material for SD



broadcasts, which is still an industry standard in many countries worldwide. This feature offers a fundamental advantage for professionals with time-sensitive SD workflows.

	HQ mode (35Mbps)	SP mode (25Mbps)	SP mode (19Mbps)	DV mode (25Mbps)
1920 x 1080	60i/50i 30p/25p/24p			
1440 x 1080	60i/50i (MOV only)	60i/50i		
1280 x 720	60p/50p 30p/25p/24p		60p/50p 30p/25p/24p	
720 x 576				50i

* The GY-HM790E supports all major HD signal formats including 1920 x 1080, 1440 x 1080 and 1280 x 720 as well as SD signal in DV codec.

Uncompressed Audio Recording with Full Manual Control

The GY-HM790E captures audio with the same uncompromising quality as video. Two-channel 16-bit/48 kHz uncompressed linear PCM can be recorded via the detachable shotgun microphone, or via a pair of balanced XLR connectors. Versatile input switching and independent channel assignment allow both mic and line-level sources (such as wireless receivers) to be connected, and phantom power is available on each XLR connector independently. Audio recording levels can be controlled automatically or manually, with an audio level meter in the viewfinder and LCD monitor for easy monitoring.



Innovation to Meet the Needs of Professionals — Native File Recording Capability

The Next Generation of Native File Access Workflow

Native File Recording for Integrated Workflows

With Native File Recording, JVC has eliminated one of the main obstacles to achieving a smoother, more streamlined production workflow. Until now, ingesting footage into editing systems was a time consuming process. With Native File Recording, your footage is ready to edit the moment it's shot.

QuickTime™ MOV File Workflow

Direct file access to Apple's Final Cut Pro™

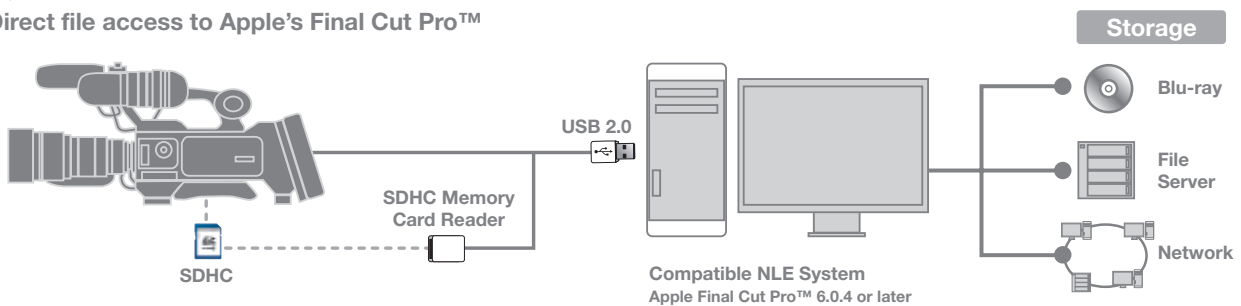

XDCAM EX™ Compatible MP4 File

Ingest MP4 clips to major NLE systems

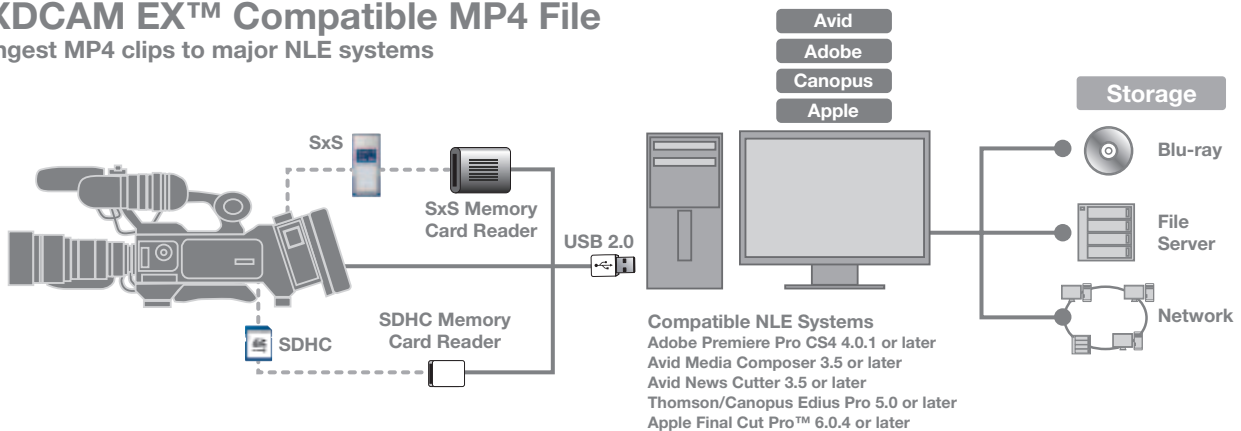

Dual Format Recording (QuickTime™ for FCP™/XDCAM EX™ Compatible MP4)

Because it uses QuickTime™ as its native file format, the GY-HM790E is the perfect choice for users of Apple's Final Cut Pro™ editing system. Both HD and SD MOV files recorded by the camcorder can be dragged directly into Final Cut Pro™, keeping them first-generation and eliminating the time-consuming process of file conversion. You'll spend less time preparing the files for editing, and more time letting your creativity get to work.

For users of major NLE systems, including solutions from Adobe, Avid, Canopus, Vegas and Apple, the GY-HM790E supports the MP4 file format, which can be brought into your editing system without re-encoding. HDV-compatible M2T files can also be created from these MP4 files using the ProHD Clip Manager (Version 1.1).

Finally, the popular type-2 AVI file format can be recorded in SD for easy import into almost all current and legacy NLE systems.

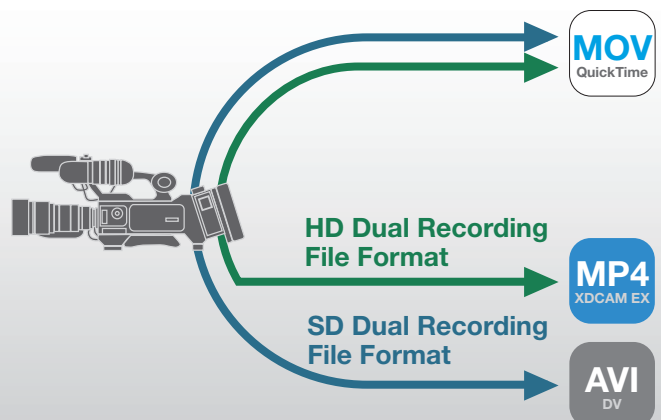

ProHD Software

Twin SDHC Card Slots with Seamless Continuous Recording

Loaded with two 32 GB Class-6 SDHC cards, the GY-HM790E is good for over six hours* of continuous HD shooting across both cards. When one card is full, the camcorder switches seamlessly and automatically to the other card. And because cards are hot swappable, there is in effect no limit to the continuous shooting time in any mode, even with lower capacity cards.

Hot swappable media also means it is possible to start editing footage from one card while still shooting to the other. The twin card slots also offer the flexibility of scene-by-scene card selection

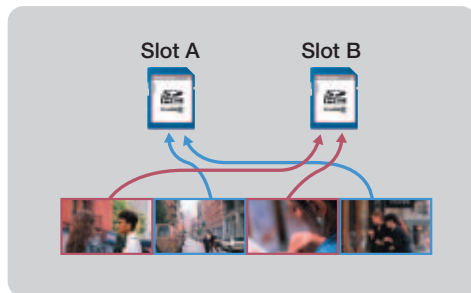
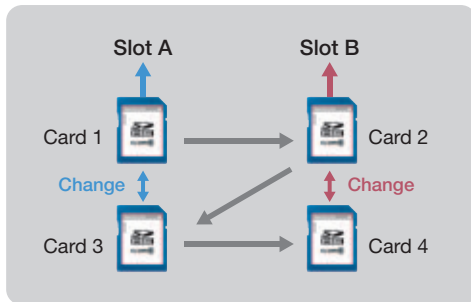

* In 19 Mbps mode

SDHC media offers the best combination of price, availability, capacity, reliability and transfer speed. With no moving parts and no pins or other extrusions, SDHC cards are both durable and reliable, and compare favourably with tape on a cost-per-minute basis.

SxS Double Media Hybrid Recording (Optional)

The optional SxS media recorder allows simultaneous shooting to SDHC and SxS media in HD 1080i or 720p. This hybrid recording system provides a reliable backup solution.



JVC ProHD Clip Manager

The ProHD Clip Manager for both Mac and Windows makes it easy to manage MP4 clips on the GY-HM790E's memory cards from your computer. With a few clicks of the mouse you can copy, move or delete clips, preview clip content, as well as view and edit clip metadata. A thumbnail view of all the clips in the current folder shows the content of each clip at a glance. Use the viewer to watch the whole clip, or change the clip's index frame used for the thumbnail. You can also manage folders to keep your clips organized, and check the remaining free space on a card. The latest version of ProHD Clip Manager offers an even greater level of NLE compatibility by enabling MP4 files to be converted to m2t widely supported by NLEs.



Main screen for Windows®

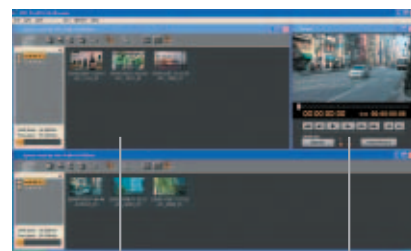

Information window

Viewer window

ProHD Log and Transfer Plug-in

The ProHD Log and Transfer Plug-in is a software for Apple's Final Cut Pro™ that lets you drop MP4 files recorded on the GY-HM790E into the clip bin of Final Cut Pro™.

With the plug-in installed, you can view thumbnails of the MP4 files on a memory card from the Log and Transfer screen of Final Cut Pro™. Simply drag and drop the thumbnails into the bin to automatically convert the clips to QuickTime™, ready for use.

Log and transfer screen

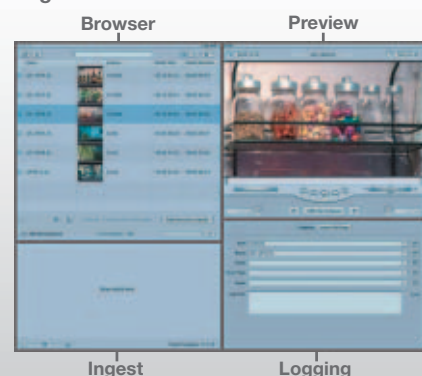

* Playback compatibility not guaranteed on all products due to variation of supported recording mode.

† MP4 is the compliant file format used on the XDCAM EX™.

* SxS is a flash memory card designed for professional video cameras with a high-speed PCI Express interface.

* All trademarks and brand names are the property of their respective proprietors.

Innovation that Meets the Needs of Professionals — Ease of Operation

Ease of Operation for Complete Creative Freedom

1.22 Megapixel LCOS Viewfinder and Focus Assist Function

The GY-HM790E features a stunning new high-resolution (852 x 480 x 3) LCOS (Liquid Crystal on Silicon) 0.45" viewfinder. The 16:9 aspect ratio image is crisper and more detailed than conventional LCD viewfinders, with higher vertical resolution and superior RGB colour separation. Helping the camera operator stay focused on the action is a focus assist system that highlights the edges of objects in the image. Also visible in the viewfinder are indicators for the audio input level, the battery time remaining, and the recording time available on each memory card.

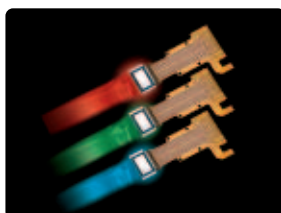

Focus Assist

With the increased resolution of HD, accurate focusing is critical—focusing errors that may pass unnoticed in SD video are far more obvious when watching in HD. JVC developed Focus Assist to make accurate HD focusing quick and easy. When Focus Assist is switched on, the image in the viewfinder or LCD monitor becomes monochrome and all objects that are in focus appear with coloured edges. Keeping the important elements in the picture in focus while shooting is greatly simplified.



Focus Assist OFF



Focus Assist ON

4.3-inch LCD Monitor

The large, high-resolution 4.3-inch 16:9 aspect ratio LCD monitor provides a wide array of monitoring and setup indications. The monitor's 800 x 480 WVGA resolution, together with the easy-to-use cross keys for GUI navigation, bring ease of use to a new level for a professional camcorder.



GUI

The new GUI features several improvements that make the GY-HM790E easier to use. All on-screen monitors can be navigated intuitively via a four-way cross key and a central Set button. A coloured LED ring illuminates the outer edge of the cross keys, indicating the current camera mode. The GUI can be viewed in both the LCD monitor and overlaid in the viewfinder. The high-resolution picture thumbnail display makes it a simple task to select clips visually for review, and more detailed file and file format, frame rate, resolution and time code data.



File Content Display



Menu Display



Item Select Over Picture



Favourite Menu Display

Shooter-Friendly Controls and Layout

The control panel of the GY-HM790E has been laid out so that all commonly used controls are within easy reach of the operator while shooting. Among the controls are three user-definable buttons that can be assigned a range of functions for instant setting.



Pre Rec Mode

How many times have you missed a crucial moment because you didn't hit the record button in time? With Pre Rec enabled, the camcorder continuously buffers up to 20 seconds of video, so that when recording is started the cached video is included in the recorded file, giving you up to 20 second head start.

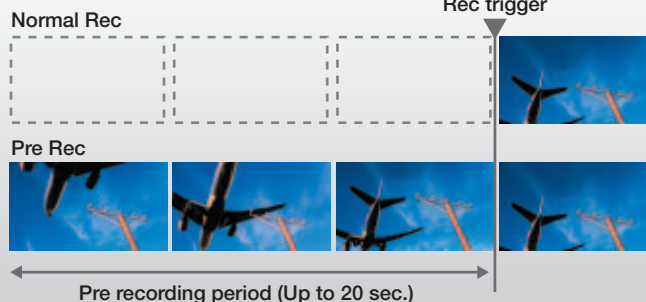

Spot Exposure Meter

When shooting high-contrast scenes, setting the exposure accurately can become tricky. The Spot Meter allows you to monitor the dynamic range of the image in various ways so that the exposure may be controlled more accurately. A manual mode allows a specific area of the image to be monitored for precise exposure control of the main subject in the frame. There are four modes of spot metering: Max/Min, Max, Min and Manual. In the Max/Min mode, the highest and lowest levels of the image are identified with colour markers, yellow (H) and green (L), along with the video level (before knee and gamma).



Remote Camera Control Connector

The GY-HM790E is equipped with a standard JVC 6-pin TTL interface for an optional remote camera controller (RM-LP25U, RM-LP57U or RM-LP55U). These units provide extensive control options, including paint, iris, gamma level, knee, gain, shutter, and black level.



Variable Frame Rate Recording (Over Crank, Under Crank)

When recording in the 720p 35 Mbps mode, the camera can be set to record at a frame rate different than the playback rate. This capability makes it possible to record slow or fast motion when the recording is played back at 24p, 25p or 30p.

Versatility and Quality of Output

SDI and IEEE1394 Output

In addition to SD composite and HD/SD component video output, the GY-HM790E is equipped with SDI and IEEE1394 outputs. The SDI output is via a BNC connector and can be switched between HD and downconverted SD with embedded uncompressed audio. The IEEE1394 output is via a 4-pin connector and delivers HDV compliant streams in HD mode and DV compliant streams in SD mode. The audio output is HDV compliant in HD mode and DV compliant in SD mode.

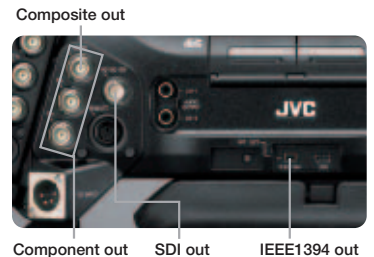

Dimensions

Unit: mm

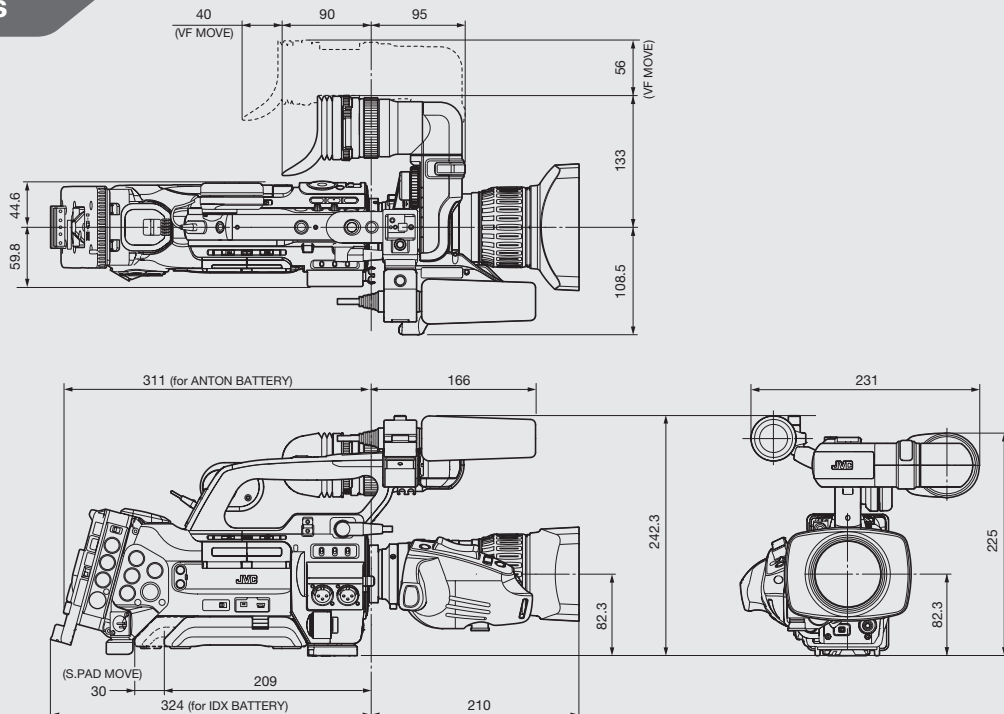

System Configuration

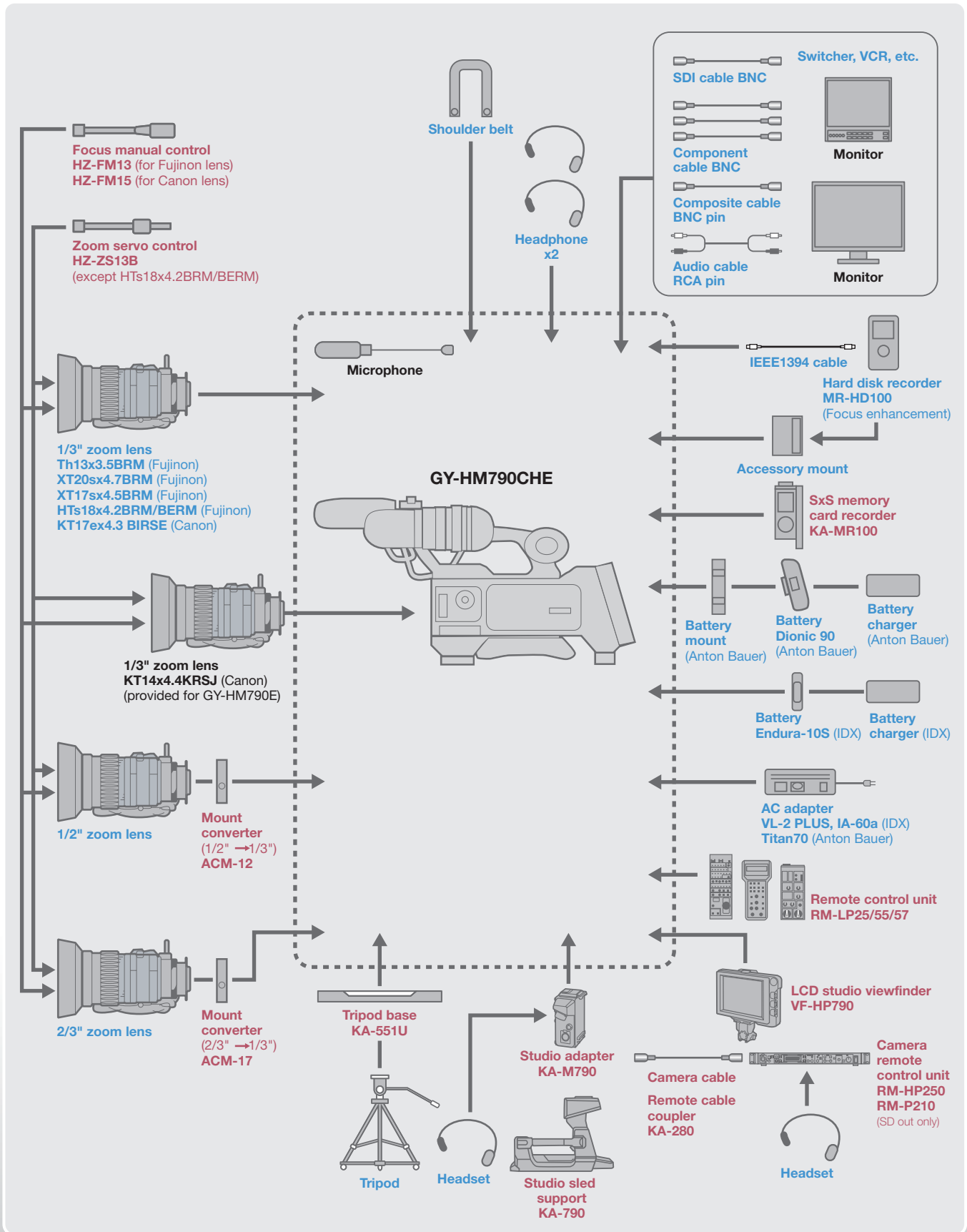

Optional Accessories



(Canon)

KT20x5BKRS

1/3" high quality zoom lens



(Canon)

KT17ex4.3BIRSE

1/3" high quality zoom lens with 2x extender



(Fujinon)

HTs18x4.2BRM

HTs18x4.2BERM
(2x extender)
1/3" high quality zoom lens



(Fujinon)

XT17sx4.5BRM

XT20sx4.7BRM
1/3" zoom lens



(Fujinon)

Th13x3.5BRM

1/3" wide zoom lens



HZ-CA13U

PL-Mount cinema prime lens adapter



ACM-12

1/2" bayonet mount converter



ACM-17

2/3" bayonet mount converter



HZ-ZS13BU

Manual zoom control

Cannot be used for HTs18x4.2BRM lens.
Use Fujinon ZMM-6: Module unit/
CZH-14: Grip/CFC-12-990: Cable/
MCA-7: Mounting clamp



HZ-FM13U (Fujinon)

HZ-FM15U (Canon)

Manual focus control

Cannot be used for KT17ex4.3BIRSE lens.
Use Canon FFM-100: Flex focus module/
FC-40: Flex cable/FFC-200: Flex focus controller



KA-M790G

Multicore studio interface unit



KA-790G

Studio sled support



RM-HP250DE (HD/SD)

Camera control unit



RM-P210E (SD)

Remote control unit



RM-LP25U RM-LP55U RM-LP57U

RM-LP25U

RM-LP55U

RM-LP57U

Remote control unit



KA-MR100G

SxS memory card recorder



(Focus enhancement)

MR-HD100E

Hard disk recorder

For m2t or SD video file recording only.



SR-HD1500EU

Blu-ray disk recorder



KM-H3000E

KM-H2500E

Multi-format digital switcher



VF-HP790G

8.4" LCD studio viewfinder



KA-551U

Tripod base V-mount adapter



VC-P112U (20m)

VC-P113U (50m)

VC-P114U (100m)

Multicore camera cable



DT-V24G1E/V20L3GE/ V17G1E/V9L3D

LCD HDTV monitor

Hybrid cables

HK-VC10HDB-SDI (10m)

HK-VC20HDB-SDI (20m)

HK-VC25HDB-SDI (25m)

HK-VC50HDB-SDI (50m)

HK-VC100HDB-SDI (100m)

(European market only)



QR-JVC-AUTO

Anton Bauer battery mount plate



Endura-E-10S (Battery)

IDX V-mount battery



VL-2PLUS (Charger)

IDX V-mount battery charger/AC adapter



Dionic 90 (Battery)

Anton Bauer battery



Tandem 70 (Charger)

Anton Bauer battery charger/AC adapter

Specifications

GY-HM790E

[General]

Power: DC 12V (11V to 17V)
 Power consumption: Approx. 27W (During recording [when the camcorder + standard lens + LCD monitor are in use])
 Mass: Approx. 3.9kg (8.6 lbs.)
 Operating temperature: 0°C to 40°C
 Operating humidity: 30 % to 80 % RH
 Storage temperature: -20°C to 60°C
 Image pickup device: 3-chip, 1/3" Progressive CCD
 Colour separation prism: F1.4, 3-colour separation prism
 Sync system: Internal sync: built-in SSG / External sync: BB, VBS signal or HD tri-sync signal
 Lens mount: 1/3" bayonet system
 ND filter: OFF, +1/4ND, +1/16ND
 Gain: 0dB, 3dB, 6dB, 9dB, 12dB, 15dB, 18dB, ALC
 Electronic shutter: 1/6 sec. to 1/10000 sec., EEI
 Minimum illumination: 1.25 lx (typical) (1920x1080 mode, F1.4, +18dB, with 8-frame accumulation)
 LCD monitor: 4.3" LCD, 800x480 (WVGA, 410,000 pixels)
 Viewfinder: 0.45" LCOS, 1.22 megapixels (852x480x3)
 Lens: Canon F1.6, 14x, f = 4.4-61.6mm (35mm conversion: 32-448mm)
 Filter diameter: 82mm
 Supported media: SDHC (Class 6 or 10)
 Slots: x 2
 Recording time: Approx. 25 minutes (8GB SDHC card, 35Mbps, VBR mode)

■ SDHC Class 6 recording time (approx.)

	MOV/MP4		MOV/AVI	
	SP	HQ	SD	
	720p	1080i	720p/1080i	576i
4GB	22 min.	17 min.	12 min.	15 min.
8GB	45 min.	35 min.	25 min.	30 min.
16GB	1 hr. 30 min.	1 hr. 10 min.	50 min.	1 hr.
32GB	3 hr.	2 hr. 20 min.	1 hr. 40 min.	2 hr.

[Video/Audio]

Recording file format: QuickTime™ file format for Final Cut Pro™ (HD/SD)/MP4 file format (HD)/AVI type-2 file format (SD)
 Recording format:
 HD: MPEG-2 Long GOP
 HQ mode: VBR, 35Mbps (1920x1080i50/60, p24/25/30) MPEG-2 MP@HL
 SP mode: CBR, 25Mbps (1440x1080i50/60)/19Mbps (1280x720p24/25/30): MPEG-2 MP@H-14/19Mbps (1280x720p50/60): MPEG-2 MP@HL
 Video SD: DV compression 4:2:0, 8-bit, 25Mbps
 Audio HD: LPCM 2ch, 48kHz/16-bit ; SD: LPCM 2ch, 48kHz/16-bit
 Video frame rate:
 PAL settings
 HD: HQ mode: 1920x1080/50i, 25p, 1440x1080/50i (MOV only), 1280x720/50p, 25p
 SP mode: 1440x1080/50i, 1280x720/50p, 25p
 PAL setting SD: 576/50i
 NTSC settings
 HD HQ mode: 1920x1080/59.94i, 29.97p, 23.98p, 1440x1080/59.94i (MOV only), 1280x720/59.94p, 29.97p, 23.98p
 SP mode: 1440x1080/59.94i, 1280x720/59.94p, 29.97p, 23.98p
 Variable frame rate (HQ 720p 24/25/30 mode):
 NTSC setting: 10/12/15/20/24/30/40/48/60 fps
 PAL setting: 10/12.5/20/25/40/50 fps

[Connectors]

Analogue composite output (480i or 576i: Downconverted, 4:3/16:9): 1.0V(p-p), 75-ohms, BNC (unbalanced; switchable from analogue component Y output)
 Analogue component output (480i or 576i: Downconverted 720p/1080i):
 Y: 1.0V(p-p), 75-ohms Pb, Pr: 0.7V(p-p), 75-ohms, BNC x 3 (unbalanced)
 SDI output terminal (480i or 576i: Downconverted/720p/1080i: embedded audio), BNC (unbalanced)
 HD-SDI: Compliant with SMPTE 292 M
 SD-SDI: Compliant with SMPTE 259 M
 Genlock input: 1.0V(p-p), 75-ohms, BNC (unbalanced)
 Audio input:
 [MIC]: -60dBu, 3k-ohms, XLR (balanced), +48V output (phantom power supply)
 [LINE]: +4dBu, 10k-ohms, XLR (balanced)
 Audio output: -8±1dBu (when audio signal process output is -20dB), 1k-ohms, RCA x 2 (unbalanced)
 Headphone: 3.5 mm mini jack (stereo) x 2
 Time code input: 0±6dBs, high impedance, BNC, unbalanced
 Time code output: 0±6dBs, low impedance, BNC, unbalanced
 IEEE1394 output: 4-pin
 Remote: Mini DIN 6-pin
 USB: Mini USB-B type, USB 2.0, mini-B, slave function (mass storage class) only

[Accessory Provided]

Microphone x 1

Final Cut Pro™ is not supplied.
 Microsoft™ and Windows™ are either registered trademarks or trademarks of Microsoft Corporation in the United States and/or other countries. Apple, Apple logo, Macintosh, QuickTime, and Final Cut Pro are trademarks of Apple Inc. registered in the United States and other countries. The SD and SDHC logos are trademarks of the SD Card Association. HDV and HDV logo are trademarks of Sony Corporation and Victor Company of Japan Limited(JVC). Product and company names mentioned here are trademarks or registered trademarks of their respective owners. XDCAM EX is a trademark of Sony Corporation.

*Simulated pictures.
 The values for weight and dimensions are approximate.
 E.&O.E. Design and specifications subject to change without notice.*



DISTRIBUTED BY



Hachioji Business Center of Victor Company of Japan, Ltd.
 has received ISO9001 Certifications.